

Data Sheet



Article number: 25075667002

Description: ICME Single-phase motor MD90 L6 0,75KW
6 - 900 rpm 1x230 Volt 50Hz B3/B5 with starting & running capacitor

Measures

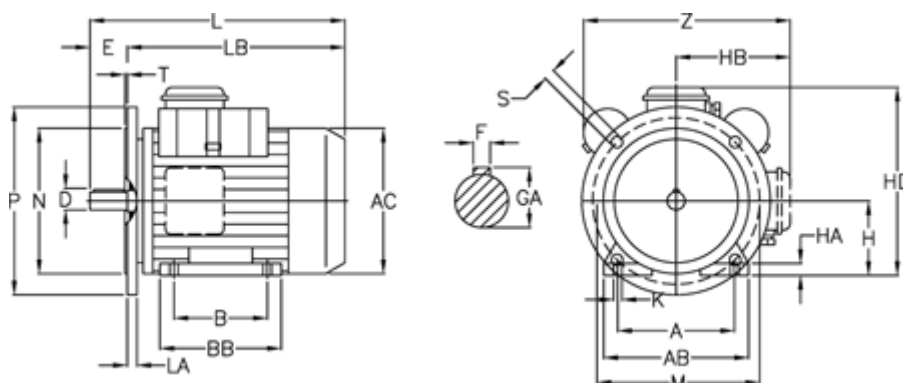

A = 140	H = 90	N = 130
AB = 184	HA = 14	P = 200
AC = 176	HB = 129	S = 11.5
B = 125	K = 9	T = 3.5
D = 24	L = 366	Z = 246
E = 50	LA = 12	
F = 8	LB = 316	
GA = 27	M = 165	